

C E R S A I E 2 0 2 4

# news

## SERICA

new collection

## MEIKE

new collection

## CHARME

collection update

## OUTDOOR 4.0

collection update

## ASPEN

collection update

## FACCIATE VENTILATE

ventilated walls



**Dado Ceramica**

Cinder 60x120  
Rigatino Bone 60x120  
Ultra Bone 60x60  $\approx$  20mm



NEW COLLECTION

# serica

**GRES PORCELLANATO IMPASTO COLORATO**  
COLORED BODY PORCELAIN STONEWARE  
GRÈS CÉRAME MASSE COLORÉ  
FEINSTEINZEUG MIT EINGEFAERBTEN SCHERBEN

SERICA formati • sizes • formats • formate

DCOF  $\geq 0.42$  R10

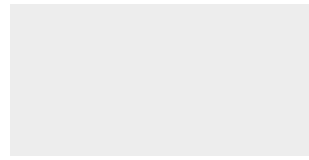

60x120 cm Rett. 24"x48" Rect.  
R10  $\approx$  9,5mm

304278 Serica Bone	581
304279 Serica Ivory	581
304280 Serica Cinder	581
304281 Serica Mud	581

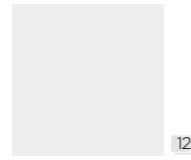

60x60 cm Rett. 24"x24" Rect.  
R10  $\approx$  8mm

304293 Serica Bone	582
304294 Serica Ivory	582
304295 Serica Cinder	582

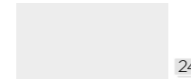

30x60 cm Rett. 12"x24" Rect.  
R10  $\approx$  8mm

304290 Serica Bone	584
304291 Serica Ivory	584
304292 Serica Cinder	584



Mosaico 5x5  
30x30 cm 12"x12" 12

304315 Serica Bone	566
304316 Serica Ivory	566
304317 Serica Cinder	566
304318 Serica Mud	566

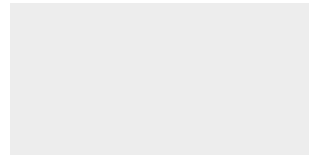

60x120 cm Rett. 24"x48" Rect.  
R11  $\approx$  9,5mm

304296 Serica Bone OUT	580
304297 Serica Ivory OUT	580
304298 Serica Cinder OUT	580

DCOF  $\geq 0.42$  R11

SERICA pezzi speciali • trims • pièces spéciales • formteile



Battiscopa 20  
7x60 cm RTT 502

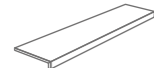

★ Gradino Frontale  
Elle Costa Retta 1  
30x120x5 cm 574



★ Gradino Angolare  
Elle Costa Retta DX 1  
30x120x5 cm 575

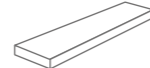

★ Gradino Angolare  
Elle Costa Retta SX 1  
30x120x5 cm 575

802490 Bone	802493 Bone	802497 Bone	802498 Bone
802491 Ivory	802494 Ivory	802499 Ivory	802500 Ivory
802492 Cinder	802495 Cinder	802501 Cinder	802502 Cinder
-	802496 Mud	802503 Mud	802504 Mud

★ Disponibili solo su ordinazione . Available on demand

SERICA OUTDOOR  $\approx$  20 mm -  $\approx$  30 mm

DCOF  $\geq 0.42$  R11

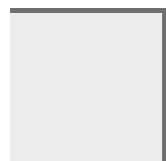

60x60 cm Rett. 24"x24" Rect.  
R11  $\approx$  20mm

304299 Ultra Serica Bone	535
304300 Ultra Serica Ivory	535
304301 Ultra Serica Cinder	535

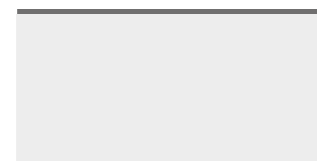

60x120 cm Rett. 24"x48" Rect.  
R11  $\approx$  20mm

304302 Ultra Serica Bone	545
304303 Ultra Serica Ivory	545
304304 Ultra Serica Cinder	545

NEW OUTDOOR  
SPECIAL PIECE  $\approx$  20 mm  $\approx$  30 mm

GRIGLIA SNODATA 25x50 cm 10"x20" 594

Produzione su richiesta, si può scegliere una larghezza da 14cm a 25cm, lunghezza fissa da 50cm, il prezzo è inteso al pezzo e non cambia in base alla larghezza scelta. Made on demand, you can choose a width from 14 cm to 25 cm, with a fixed length of 50 cm. The price is per piece and does not change based on the chosen width.



60x60 cm Rett. 24"x24" Rect.  
R11  $\approx$  30mm

304305 Ultra Serica Bone	550
304306 Ultra Serica Ivory	550
304307 Ultra Serica Cinder	550

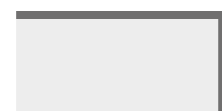

40x80 cm Rett. 16"x32" Rect.  
R11  $\approx$  30mm

304308 Ultra Serica Bone	527
304309 Ultra Serica Ivory	527
304310 Ultra Serica Cinder	527

SERICA colori • colors • couleurs • farben

BONE



IVORY









CINDER



MUD



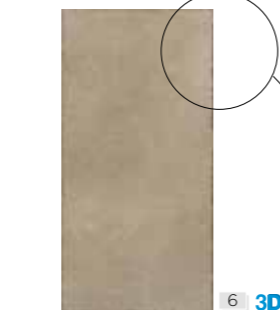

			
<b>304282</b> Rigatino Serica Bone <b>60x120 cm Rett.</b> 24"x48" Rect. 544 ■	<b>304283</b> Rigatino Serica Ivory <b>60x120 cm Rett.</b> 24"x48" Rect. 544 ■	<b>304284</b> Rigatino Serica Cinder <b>60x120 cm Rett.</b> 24"x48" Rect. 544 ■	<b>304285</b> Rigatino Serica Mud <b>60x120 cm Rett.</b> 24"x48" Rect. 544 ■
			
<b>304286</b> Spaccatella Serica Bone <b>60x120 cm Rett.</b> 24"x48" Rect. 585 ■	<b>304287</b> Spaccatella Serica Ivory <b>60x120 cm Rett.</b> 24"x48" Rect. 585 ■	<b>304288</b> Spaccatella Serica Cinder <b>60x120 cm Rett.</b> 24"x48" Rect. 585 ■	<b>304289</b> Spaccatella Serica Mud <b>60x120 cm Rett.</b> 24"x48" Rect. 585 ■

**SPACCATELLA**  
Domanda di brevetto depositata  
Patent pending  
Demande de brevet déposée  
Eingereichte Patentanmeldung

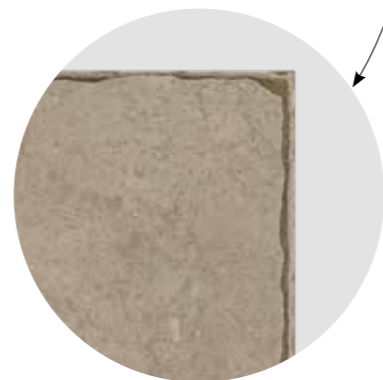

SERICA pesi e misure • weight and sizes • poids et mesures • gewichte und verpackungen

dimensioni sizes dimensions abmessungen	spessore thickness épaisseur stärke	pz/collo pcs/box pc/boite stk/ktn	mq/collo sqm/box m/boite qm/ktn	kg/collo kg/box kg/boite kg/ktn	colli/pallet box/europal boites/europal ktn/europal	mq/pallet sqm/pallet m/pallet qm/pallet	kg/europal kg/europal kg/europal kg/europal
Fondo 60x120 Rettificato	9,5 mm	2	1,44	30,50	35	50,40	1090
Fondo 60x60 Rettificato	8 mm	5	1,80	31,25	32	57,60	1020
Fondo 30x60 Rettificato	8 mm	10	1,80	31,25	32	57,60	1020
Rigatino 60x120 Rettificato	9,5 mm	2	1,44	30,50	35	50,40	1090
Spaccatella 60x120 Rettificato	9,5 mm	2	1,44	30,50	35	50,40	1090
Fondo 60x120 Rettificato	20 mm	1	0,72	32,50	30	21,60	995
Fondo 60x60 Rettificato	20 mm	2	0,72	31,60	30	21,60	975
Fondo 40x80 Rettificato	30 mm	2	0,64	42,00	27	17,28	1160
Fondo 60x60 Rettificato	30 mm	1	0,36	25,00	40	14,40	1025



*serica*

Cinder 60x120  
Rigatino Bone 60x120  
Ultra Bone 60x60  $\neq$  20mm



# meike

**GRES PORCELLANATO IMPASTO COLORATO**  
COLORED BODY PORCELAIN STONEWARE  
GRÈS CÉRAME MASSE COLORÉ  
FEINSTEINZEUG MIT EINGEFAERBTEN SCHERBEN



*meike*

**Acero 20x122 | Decoro Flora Rigatino 60x120**  
**Geology Sabbia 60x120**

meike

Quercia 30x122



**MEIKE formati** • sizes • formats • formate

DCOF  $\geq 0,42$  R10

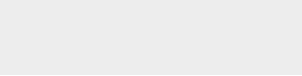
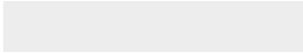
 14	 21
<b>30x122 cm Rett.</b> 12"x48" Rect. <b>R10 <math>\geq 9,5</math>mm</b>	<b>20x122 cm Rett.</b> 8"x48" Rect. <b>R10 <math>\geq 9,5</math>mm</b>
<b>304271</b> Meike Acero 525 ■	<b>304267</b> Meike Acero 525 ■
<b>304272</b> Meike Rovere 525 ■	<b>304268</b> Meike Rovere 525 ■
<b>304274</b> Meike Quercia 525 ■	<b>304270</b> Meike Quercia 525 ■
<b>304273</b> Meike Betulla 525 ■	<b>304269</b> Meike Betulla 525 ■

**MEIKE decori** • decors • dekore • Decoraciones



**005723**  
Decoro Flora Rigatino 547 ■

**60x120 cm Rett.** 24"x48" Rect.  
**R10  $\geq 9,5$ mm**  
3 Soggetti Mix

La ripresa grafica tra le diverse lastre di Decoro FLORA RIGATINO può avere una tolleranza contenuta in 3mm. I decori hanno un unico verso di posa. The tile graphic between the different slabs of Decoro FLORA RIGATINO could have a tolerance included in 3 mm. Decors have a single direction of installation. La suite graphique des différents Decoro FLORA RIGATINO peut avoir une tolérance limitée de 3cm. Les décors ont un sens unique d'installation. Die graphische Wiederholung zwischen den verschiedenen Decoro FLORA RIGATINO kann eine Toleranz innerhalb von 3 mm. aufweisen. Dekore haben eine einzige Installationsrichtung.

**MEIKE pezzi speciali** • trims • pièces spéciales • formteile

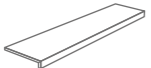
			
<b>Battiscopa</b> 20 ■ 6x61 cm RTT 503 ■	<b>Gradino Frontale</b> <b>Elle Costa Retta</b> 1 ■ 30x122x5 cm 569 ■	<b>Gradino Angolare</b> <b>Elle Costa Retta DX</b> 1 ■ 30x122x5 cm 573 ■	<b>Gradino Angolare</b> <b>Elle Costa Retta SX</b> 1 ■ 30x122x5 cm 573 ■
<b>802505</b> Acero	<b>802478</b> Acero	<b>802482</b> Acero	<b>802486</b> Acero
<b>802506</b> Rovere	<b>802479</b> Rovere	<b>802483</b> Rovere	<b>802487</b> Rovere
<b>802507</b> Quercia	<b>802481</b> Quercia	<b>802485</b> Quercia	<b>802489</b> Quercia
<b>802508</b> Betulla	<b>802480</b> Betulla	<b>802484</b> Betulla	<b>802488</b> Betulla

\* Disponibili solo su ordinazione . Available on demand

**MEIKE pesi e misure** • weight and sizes • poids et mesures • gewichte und verpackungen

dimensioni sizes dimensions abmessungen	spessore thickness epaisseur stärke	pz/collo pcs/box pc/boite stk/ktn	mq/collo sqm/box m/boite qm/ktn	kg/collo kg/box kg/boite kg/ktn	colli/pallet box/europal boites/europal ktn/europal	mq/pallet sqm/pallet m/pallet qm/pallet	kg/europal kg/europal kg/europal kg/europal
Fondo 30x122 RTT	9,5 mm	4	1,46	29,50	36	52,70	1090
Fondo 20x122 RTT	9,5 mm	5	1,22	23,50	45	54,90	1085
Decoro Flora Rigatino 60x120 RTT	9,5 mm	2	1,44	30,50	35	50,40	1090

**MEIKE colori** • colors • couleurs • farben

ACERO



ROVERE



QUERCIA



BETULLA





Fumè 60x120  
Antracite 60x120

## COLLECTION UPDATE

NUOVI COLORI NEL FORMATO 60x120 cm  
NEW COLORS IN 60x120 cm 24"x48" SIZE

# aspen

GRES PORCELLANATO IMPASTO COLORATO  
COLORED BODY PORCELAIN STONEWARE  
GRÈS CÉRAME MASSE COLORÉ  
FEINSTEINZEUG MIT EINGEFAERBTEN SCHERBEN

BIANCO

BEIGE

FUMÈ

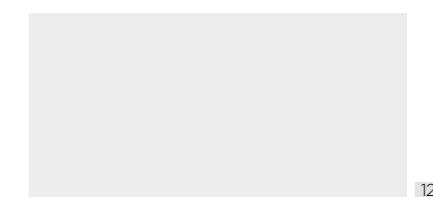

60x120 cm Rett. 24"x48" Rect.  
R10  $\approx$  9,5mm

005065A Aspen Bianco **NEW** 534

005713 Aspen Beige **NEW** 534

005714 Aspen Fumè **NEW** 534

Già in gamma Already in range

R03938A Aspen Grigio 534

R03937A Aspen Antracite 534

pezzi speciali • trims • pièces spéciales • formteile

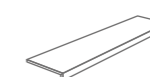

\* Gradino Frontale  
Elle Costa Retta 1  
30x120x5 cm 574

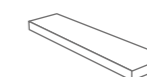

\* Gradino Angolare  
Elle Costa Retta 1  
30x120x5 cm 575

005784 Bianco 005787 Bianco DX 005790 Bianco SX

005785 Beige 005788 Beige DX 005791 Beige SX

005786 Fumè 005789 Fumè DX 005792 Fumè SX

\* Disponibili solo su ordinazione . Available on demand

Ivory 59x118 Lappato Plus  
Rigatino Black 60x120



## COLLECTION UPDATE

**NUOVO DECORO RIGATINO E FINITURA LAPPATA**  
NEW RIGATINO DECOR AND POLISHED FINISH

# charme

**GRES PORCELLANATO IMPASTO COLORATO**  
COLORED BODY PORCELAIN STONEWARE  
GRÈS CÉRAME MASSE COLORÉ  
FEINSTEINZEUG MIT EINGEFAERBTEN SCHERBEN

**CHARME formati e decori** • sizes and decors • formats et decoraciones • formate und dekore



**59x118 cm Rett.**  
23"x46.5" Rect. 542 ■  
**LAPPATO PLUS**  $\approx$  9,5mm

**304312** Charme Pearl  
**304311** Charme Ivory  
**304313** Charme Grey  
**304314** Charme Black

**304276**  
Rigatino Charme Pearl  
**60x120 cm Rett.**  
24"x48" Rect. 544 ■

**304265**  
Rigatino Charme Grey  
**60x120 cm Rett.**  
24"x48" Rect. 544 ■

**304275**  
Rigatino Charme Ivory  
**60x120 cm Rett.**  
24"x48" Rect. 544 ■

**304277**  
Rigatino Charme Black  
**60x120 cm Rett.**  
24"x48" Rect. 544 ■



**CHARME pesi e misure** • weight and sizes • poids et mesures • gewichte und verpackungen

dimensioni sizes dimensions abmessungen	spessore thickness epaisseur stärke	pz/collo pcs/box pc/boite stk/ktn	mq/collo sqm/box m/boite qm/ktn	kg/collo kg/box kg/boite kg/ktn	colli/pallet box/euopal boites/euopal ktn/euopal	mq/pallet sqm/pallet m/pallet qm/pallet	kg/euopal kg/euopal kg/euopal kg/euopal
Fondo 59x118 Rettificato	9,5 mm	2	1,39	30,50	35	48,72	1090
Rigatino 60x120 Rettificato	9,5 mm	2	1,44	30,50	35	50,40	1090

# news outdoor 4.0

DOF 3042 R11

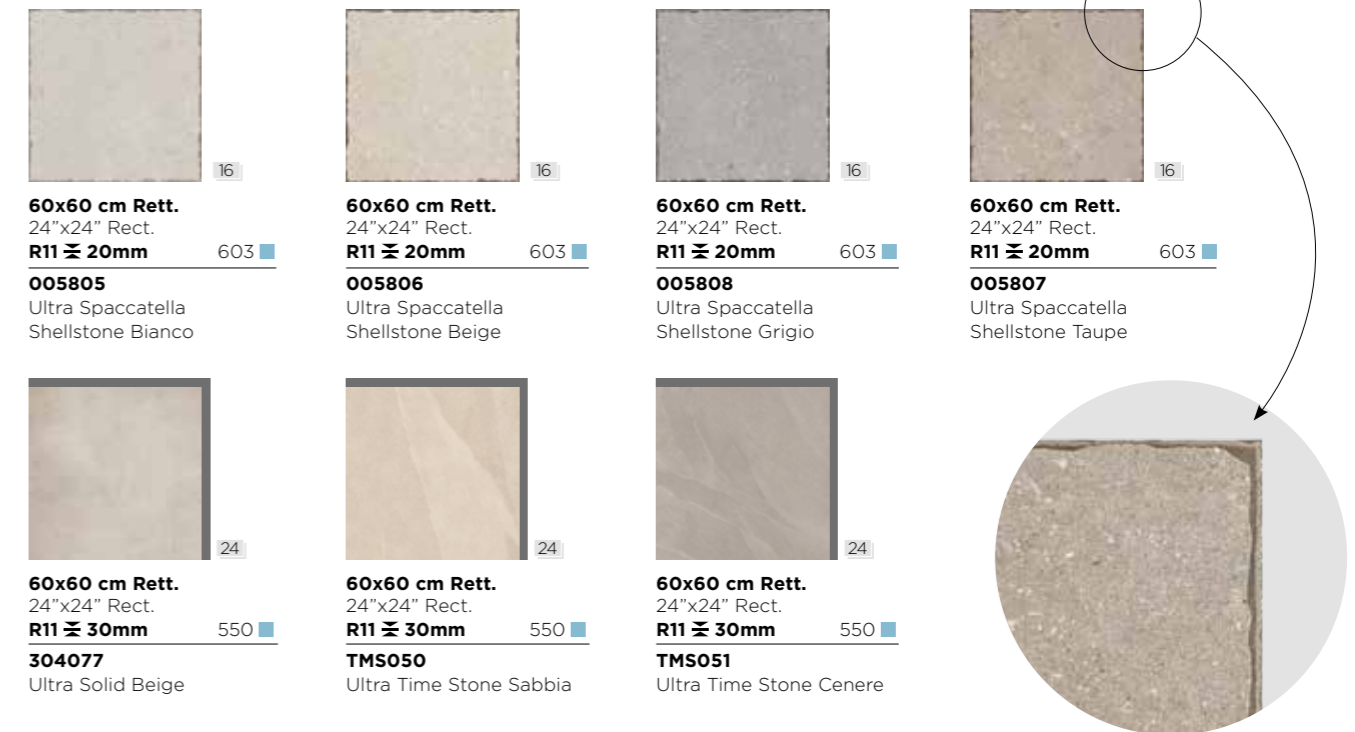

**60x60 cm Rett.**  
24"x24" Rect. **R11**  $\approx$  20mm 603 ■

**005805**  
Ultra Spaccatella  
Shellstone Bianco

**60x60 cm Rett.**  
24"x24" Rect. **R11**  $\approx$  20mm 603 ■

**005806**  
Ultra Spaccatella  
Shellstone Beige

**60x60 cm Rett.**  
24"x24" Rect. **R11**  $\approx$  20mm 603 ■

**005808**  
Ultra Spaccatella  
Shellstone Grigio

**60x60 cm Rett.**  
24"x24" Rect. **R11**  $\approx$  20mm 603 ■

**005807**  
Ultra Spaccatella  
Shellstone Taupe

**60x60 cm Rett.**  
24"x24" Rect. **R11**  $\approx$  30mm 550 ■

**304077**  
Ultra Solid Beige

**60x60 cm Rett.**  
24"x24" Rect. **R11**  $\approx$  30mm 550 ■

**TMS050**  
Ultra Time Stone Sabbia

**60x60 cm Rett.**  
24"x24" Rect. **R11**  $\approx$  30mm 550 ■

**TMS051**  
Ultra Time Stone Cenere



**SPACCATELLA**  
Domanda di brevetto depositata  
Patent pending  
Demande de brevet déposée  
Eingereichte Patentmeldung

**NEW OUTDOOR SPECIAL PIECE**  $\approx$  20 mm  $\approx$  30 mm

**GRIGLIA SNODATA**

**25x50 cm** 10"x20"  
594 ■

Produzione su richiesta, si può scegliere una larghezza da 14cm a 25cm, lunghezza fissa da 50cm, il prezzo è inteso al pezzo e non cambia in base alla larghezza scelta. Made on demand, you can choose a width from 14 cm to 25 cm, with a fixed length of 50 cm. The price is per piece and does not change based on the chosen width.



**OUTDOOR pesi e misure** • weight and sizes • poids et mesures • gewichte und verpackungen

dimensioni sizes dimensions abmessungen	spessore thickness epaisseur stärke	pz/collo pcs/box pc/boite stk/ktn	mq/collo sqm/box m/boite qm/ktn	kg/collo kg/box kg/boite kg/ktn	colli/pallet box/euopal boites/euopal ktn/euopal	mq/pallet sqm/pallet m/pallet qm/pallet	kg/euopal kg/euopal kg/euopal kg/euopal
Fondo 60x60 Rettificato	30 mm	1	0,36	25,00	40	14,40	1025

Una "facciata o parete ventilata" rappresenta la facciata di un edificio caratterizzata da un rivestimento esterno costituito da elementi di varia natura come piastrelle e/o lastre in gres porcellanato, doghe, tavole, ecc. contraddistinti dalla messa in opera a secco tramite dispositivi di sospensione e di fissaggio di tipo meccanico o chimico-meccanico, che ne mantengono distanziato il lato nascosto dalla retrostante parete di tamponamento.

Su questa viene generalmente applicato un isolamento a cappotto che realizza una sottile intercapedine entro la quale può circolare l'aria esterna. Le facciate ventilate garantiscono quindi ottime performance sia in inverno che in estate, adatte sia alle nuove costruzioni che per gli interventi di riqualificazione di costruzioni esistenti.

Le prestazioni termo-energetiche sono ottime e, combinate alla flessibilità architettonica ed estetica, rappresentano i motivi per cui questi sistemi di posa sono sempre più diffusi nell'architettura contemporanea.

**I vantaggi delle facciate ventilate:**

- Importantissimo risparmio energetico, grazie alla ventilazione dell'intercapedine e all'isolante, che elimina i ponti termici;
- Isolamento acustico, fungendo da barriera protettiva;
- Salvaguardia delle pareti dagli agenti atmosferici e dagli sbalzi termici;
- Eliminazione dei problemi di condensa superficiale e di umidità;
- Manutenzione semplice, i pannelli sono quasi sempre ispezionabili per eventuali verifiche tecniche;
- Elevato valore architettonico ed estetico.

A "ventilated facade or wall" is the facade of a building characterized by an external coating.

This coating consists of various elements such as porcelain stoneware tiles and slabs, slats, etc. and is characterized by dry installation by mechanical or chemical-mechanical suspension and fixing devices, which keeps the hidden side separate from the rear wall behind.

An external insulation is generally applied on this to create a thin cavity allowing the circulation of external air. Therefore, ventilated walls guarantee excellent performances both in winter and in summer and are suitable for both new buildings and requalification of existing ones.

The thermo-energetic performances are excellent and combined with the architectural and aesthetic flexibility, for which these systems are becoming more and more popular in contemporary architecture.

**The advantages of ventilated facades:**

- Important energy savings thanks to the ventilation of the interspace, which eliminates thermal bridges;
- Acoustic insulation, acting as a protective barrier;
- Protection of the walls against atmospheric agents and thermal shocks.
- Elimination of humidity on the surfaces;
- Easy maintenance, the panels can always be inspected for any technical check;
- High architectural and aesthetic value.

**SEZIONE ORIZZONTALE**  
HORIZONTAL SECTION  
SECTION HORIZONTALE  
HORIZONTALER ABSCHNITT

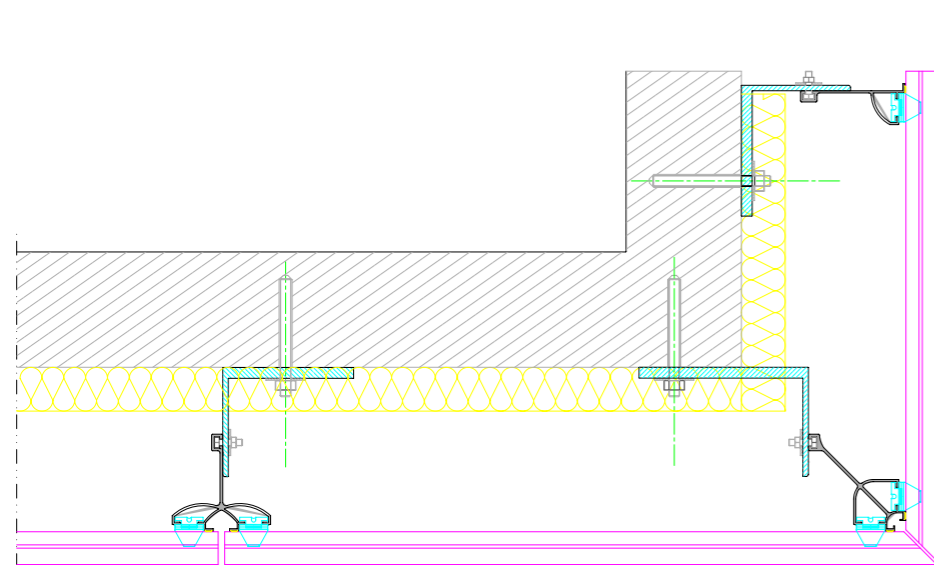

**SEZIONE VERTICALE**  
VERTICAL SECTION  
SECTION VERTICALE  
VERTIKALER ABSCHNITT

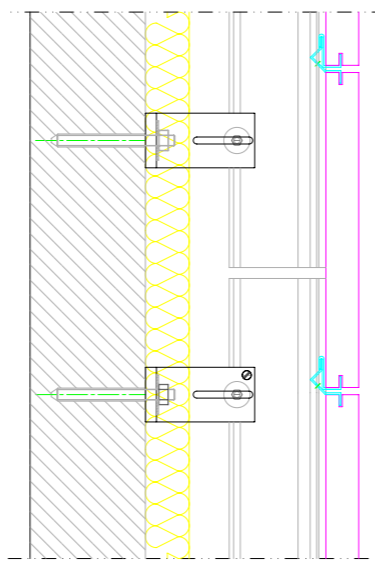

**PROGETTI SU MISURA, REALIZZATI GRAZIE AL NOSTRO SUPPORTO TECNICO DEDICATO.**  
CUSTOM MADE PROJECTS DEVELOPED THANKS TO OUR DEDICATED TECHNICAL SUPPORT.  
PROJETS SUR MESURE, RÉALISÉS GRÂCE À NOTRE SUPPORT TECHNIQUE DÉDIÉ.  
MASSGESCHNEIDERTE PROJEKTE, DIE DANK UNSERER TECHNISCHE UND GEZIELTE UNTERSTÜTZUNG GEMACHT WERDEN.

**È RICHIESTO UN LOTTO MINIMO DI PRODUZIONE. PER MAGGIORI DETTAGLI SI PREGA DI CONSULTARE L'AGENTE O IL FUNZIONARIO DI ZONA.** MINIMUM QUANTITIES REQUIRED. FOR MORE DETAILS PLEASE CHECK WITH YOUR SALES REPRESENTATIVE.  
LOT MINIMUM DE PRODUCTION IMPÉRATIVE. // POUR ULTÉRIEURES INFORMATIONS MERCI DE CONTACTER L'AGENT D'USINE OU BIEN L'AREA MANAGER. // ES WIRD EIN MINIMUM PRODUKTIONSBESTAND GEFRAGT. FÜR WEITERE UND ZUSÄTZLICHE ERKLÄRUNGEN BITTE DEN GEBIETSVERTRETER ODER DEN ZUSTAENDIGEN VERKAUFSLEITER FRAGEN.

Une « façade ou mur ventilé » est un système de revêtement extérieur réalisé par l'installation à sec de différents éléments tels que carreaux et/ou grandes dalles en grès cérame, lattes etc. La mise en oeuvre est réalisée généralement par la réalisation d'une couche d'isolation. Sur cette couche on utilise de supports spéciaux et dispositifs de fixation qui garantissent un système d'ancrage mécanique ou bien chimique-mécanique des dalles.

Grâce à cette structure, entre le mur porteur et le matériel de revêtement il y a toujours une lame d'air qui permet une ventilation continue. Les façades ventilées garantissent donc des excellentes performances soit en été soit en hiver. Elles peuvent être adaptées à la fois aux nouveaux bâtiments et aux bâtiments existants avec un travail de réaménagement et requalification de la façade.

Les performances thermo-énergétiques sont excellentes et, combinées à la flexibilité architecturale et esthétique, représentent la raison pour laquelle ces systèmes de pose sont de plus en plus populaires dans l'architecture contemporaine.

**Les avantages des façades ventilées :**

- Economie d'énergie très importante grâce à la cavité de ventilation et la couche d'isolation. Cette technologie élimine les ponts thermiques ;
- Isolation acoustique agissant comme une barrière de protection ;
- Protection des murs contre les agents atmosphériques et contre les variations brusques de température ;
- Elimination des problèmes de condensation et humidité ;
- Entretien simple de la façade, les panneaux sont presque toujours inspectables pour éventuels contrôles techniques ;
- Haute valeur architectural et esthétique.

Eine „Fassade oder belüftete Wand“ repräsentiert die Fassade von ein Gebäude, das durch eine Außenverkleidung aus Elementen verschiedener Art gekennzeichnet ist. Dies können Feinsteinzeugfliesen und/oder Platten, Diele, usw. sein, ausgezeichnet durch die Trockenmontage mit Aufhängungsvorrichtungen mit mechanischen oder chemisch-mechanischen Befestigung, die die verborgene Seite der dahinter liegenden Fuellwand auf Abstand halten

Hierzu wird in der Regel eine Isolierung angebracht, der einen dünnen Hohlraum die Außenluft zirkulieren lassen kann. Die belüfteten Fassaden garantieren daher hervorragende Leistungen sowohl im Winter als auch in Sommer, geeignet für Neubauten und Sanierung bestehender Gebäude.

Die thermoenergetische Leistung ist ausgezeichnet und kombiniert zur architektonischen und ästhetischen Flexibilität repräsentieren die Gründe, warum diese Installationssysteme immer beliebter in der zeitgenössischen Architektur werden.

**Die Vorteile belüfteter Fassaden:**

- Sehr wichtige Energieeinsparung dank Belüftung des Hohlraums und der Isolierung, Wärmeschutz, die Waermebruecken beseitigt.
- Schalldämmung als Schutzbarriere;
- Schutz der Wände vor Witterungseinflüssen und vor thermische Veränderungen;
- Beseitigung der Probleme der Oberflächenkondensation und Feuchtigkeit;
- Einfache Wartung, die Paneele können fast immer inspiziert werden für technische Überprüfungen;
- Hoher architektonischer und ästhetischer Wert.

**DETTAGLIO INTAGLIO PIASTRELLA . FOCUS DETAILS .**  
DETAIL DU CARREAU SCULPTE . FLIESENDETAIL .

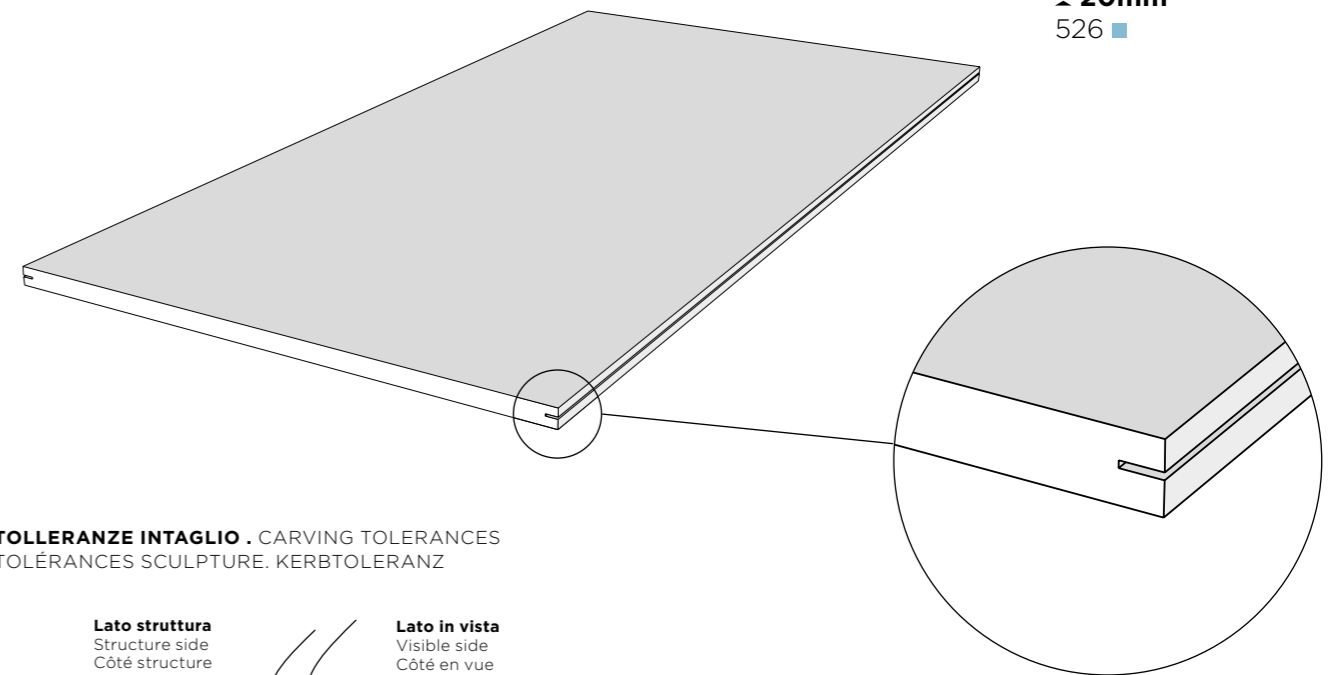

**60x120 cm Rett.**  
24"x48" Rect.  
± 20mm  
526 ■

**TOLLERANZE INTAGLIO . CARVING TOLERANCES**  
TOLÉRANCES SCULPTURE . KERBTOLERANZ

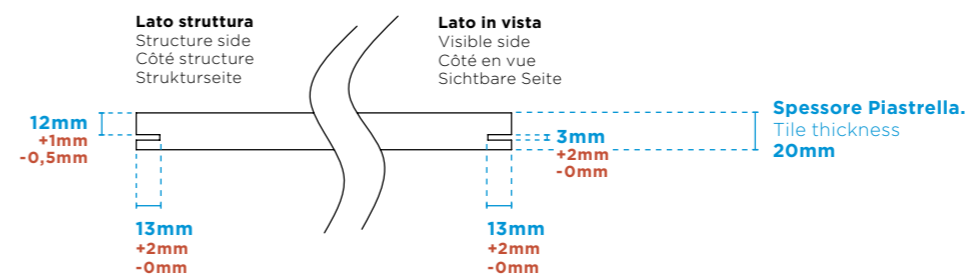

Imballi, colori e misure sono soggetti a inevitabili variazioni. Le informazioni contenute nel presente catalogo sono il più possibile esatte, ma non sono da ritenersi **legalmente vincolanti**. / Packings, colours and sizes are subject to inevitable variations. The information contained in this catalogue is correct to the best of our knowledge, but it is not construed as legally binding. / Changements de poids, nuances et dimensions sont typiques et inevitable. Les renseignements donnés dans ce catalogue sont le plus possible exacts, sans avoir effet obligatoire. / Verpackungen, Farbe und Masse der Fliesen unterliegen unvermeidlichen Veränderungen. Die im vorliegenden Katalog enthaltenen Angaben sind so genau wie möglich gehalten, sind aber auch rechtlich nicht verbindlich.



**Dado Ceramica**



Ceramics of Italy

**Dado Ceramica S.r.l.** Via Sicilia 21 - 40017 San Matteo della Decima (BO) - Italy  
Tel. +39 051 6819611 Fax +39 051 6819650 info@dadoceramica.it [www.dadoceramica.it](http://www.dadoceramica.it)